

# Data Sheet



Article number: 12513700030100  
Description: KLEE-coil 513 700 030.100  
M3 Hardened, zinc-pl.

## Measures

---

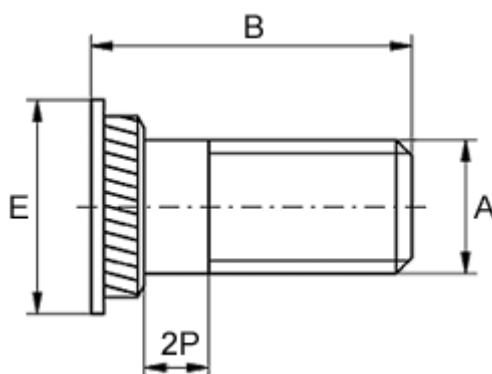

For plate thickness, min	= 1.5
Head diameter E	= 6
Hole diameter +0.1	= 4.2
Length B	= 13
Male thread A	= M3x0,5
Min distance to edge	= 2.4